



RS0094 - REAR DISC

FITTING INSTRUCTIONS

1. Ensure the axle is completely clean and slide the disc carefully on to the axle, taking care not to force the bearing inner ring out of alignment.

2. If the bearing inner ring has moved outwards by a few millimetres, **it must be re-aligned with the outer ring before fitting the retaining nut.** Rotate the disc by hand while simultaneously re-aligning the bearing inner ring. If necessary, slide a cylindrical tool over the axle to push the bearing ring backwards.

SEE REVERSE FOR DIAGRAM

{Please note that simply tightening the retaining nut will not always re-align the bearing inner ring correctly, and the bearing will suffer from excessive free play and noise}

3. Using a **new** retaining nut and a suitable torque spanner, tighten to the recommended torque of 210Nm (156lbf ft) while simultaneously rotating the disc by hand.

To ensure correct bearing adjustment and extended service life, it is very important that the correct torque is applied and the disc is rotated as the nut is tightened.

WARNING: FAILURE TO FOLLOW THESE FITTING INSTRUCTIONS MAY INVALIDATE YOUR WARRANTY

SUGGESTED TECHNIQUE TO ENSURE CORRECT BEARING ALIGNMENT
BEFORE FITTING HUB NUT

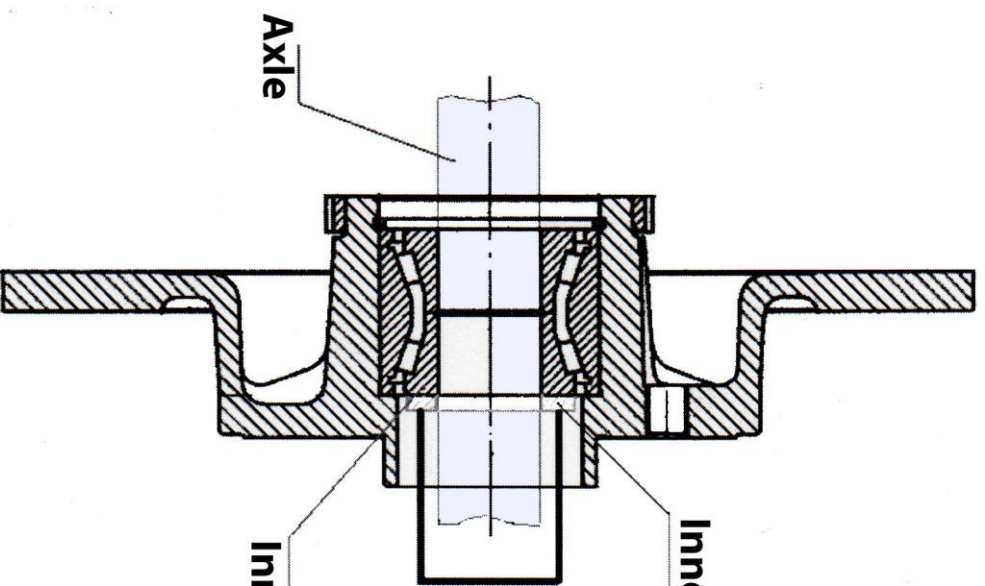

Inner ring moved out several millimetres

If necessary, push a cylindrical tool over the axle to push the inner ring backwards while simultaneously rotating the disc.

Inner ring in the correct position

Axle